

## Retail price list



## PRICE LIST (netto) No. 41-KDA-2023

Electric curtain rods motorised by Somfy are a functional solution for your space. With its minimalist design, the curtain rod will be ideal for homes, flats, meeting rooms and hotels. Depending on your choice of motor, you can control the curtain rod with a wall transmitter, remote control or an app. With the help of such an app, you will be able to cover or uncover your windows from anywhere, however you need it. Curtain

rod motors give you the option of programming scenarios so that they run themselves, depending on the time of day. Plus, if you have a smart home system, then you can attach your curtain rod to the control base. We offer three types of curtain rods, ranging from the economical version to the premium version, in which the curtain's movement is smooth, adjustable and always very quiet.



LOWEST PRICE, HIGH QUALITY

Net price [EUR] - Rail

szer. [cm]	300	350	400	450	500	550	600	650	700	750	800	850	900	950	1000
	133	149	165	182	198	220	236	253	269	285	302	318	334	351	367

**Properties:**

- White-coloured rail
- Ceiling mounting
- One-sided extension
- Sliding speed 15 cm/s
- Max weight of curtain 35 kg
- Max load of slider 1.5 kg
- 10 sliders/m of rail
- Maximum width of straight rail:
  - with wired motor: 10 m
  - with battery motor: 6 m

**Surcharges (see pages 5-6):**

- Wall mounting
- Movelite motors and controls
- Theatre extension ..... 9 €
- Ready-made curtain with microflex hooks (ask the dealer)
- Other RAL colours (ask dealer)

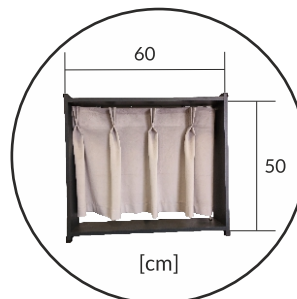

Display with motor for battery: 360 €



Movelite WireFree 35 RTS with battery motor:  
*Energy saving;  
no damage to the wall*





# HEAVY DUTY

curtain rod



**HEAVY-DUTY SLIDERS, POWERFUL MOTOR  
FOR CURTAINS WITH A TOTAL WEIGHT OF 60 KG**

**Net price [EUR] - Rail**

szer. [cm]	300	350	400	450	500	550	600	650	700	750	800	850	900	950	1000	1050	1100	1150	1200
	233	262	292	321	351	385	415	444	474	504	533	563	592	622	651	686	716	745	775

**Properties:**

- White rail
- Ceiling mounting
- One-sided extension
- Adjustable sliding speed  
from 7.5-20 cm/sec.
- 10 sliders/m of rail
- Max curtain weight 60 kg
- Max rail width:
  - straight: 12 m
  - bent: 6 m



Glydea rail



Glydea Ultra motor

**Surcharges (see pages 5-6):**

- Wall mounting
- Glydea motors and controls
- Fabric wrinkling
- Rail bending in 45° and 90° ..... 128 €
- Theatrical stretching ..... 19 €
- Ready-made curtain sewn in three variants (ask the dealer)

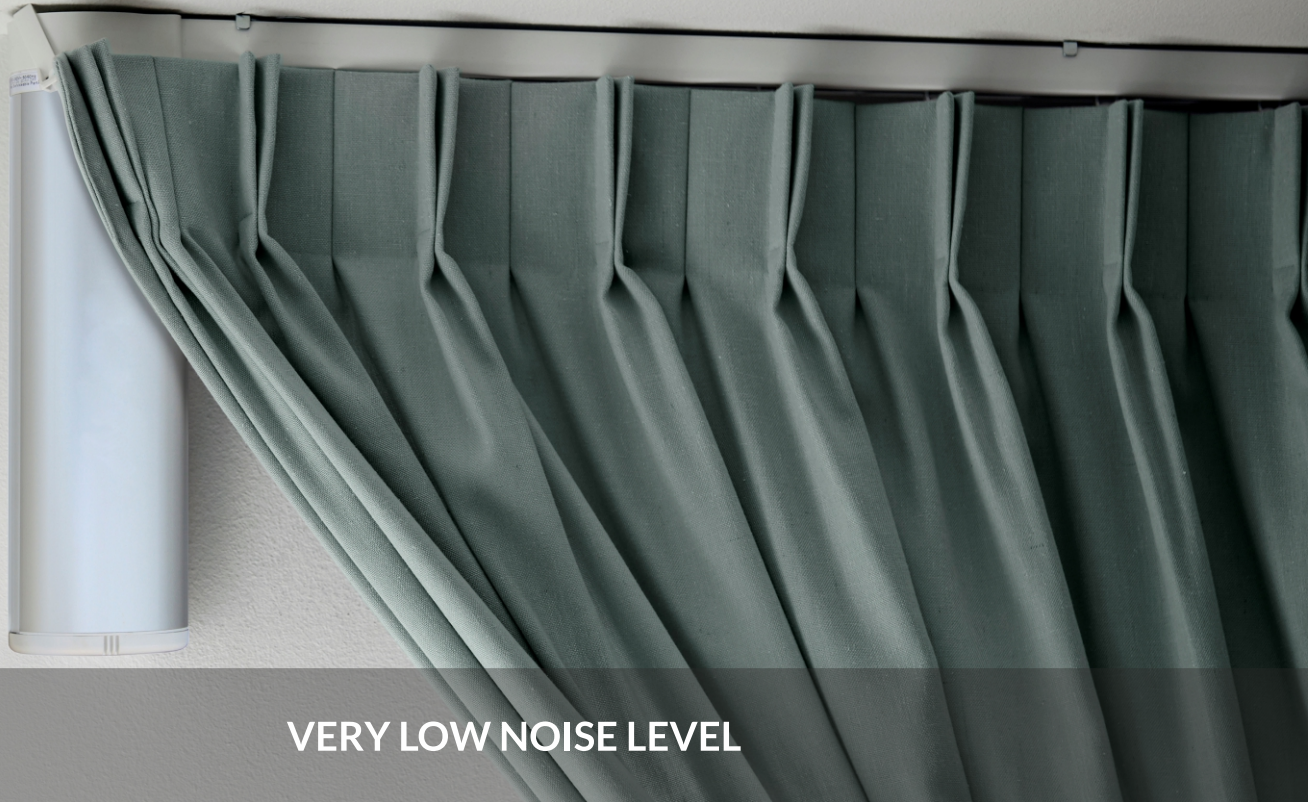

VERY LOW NOISE LEVEL

Net price [EUR] - Rail

szer. [cm]	300	350	400	450	500	550	600	650	700	750	800	850	900	950	1000	1050	1100	1150	1200
	253	286	319	352	385	423	456	489	522	555	588	621	654	687	720	759	791	824	857

**Properties:**

- Trolley and sliders for quiet operation
- White rail
- Ceiling mounting
- One-sided extension
- Adjustable sliding speed from 7.5-20 cm/sec.
- 10 sliders/m of rail
- Max curtain weight 60 kg
- Max rail width:
  - straight: 12 m
  - bent: 6 m

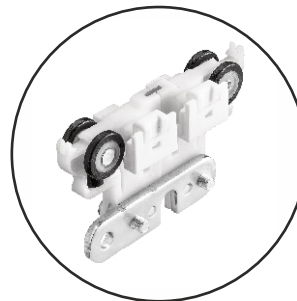

Silent trolley



Silent slide

**Surcharges (see pages 5-6):**

- Wall mounting
- Glydea motors and controls
- **NEW!** Fabric wrinkling
- Rail bending in 45° and 90° ..... 128 €
- Theatrical stretching ..... 20 €
- Ready-made curtain sewn in three variants (ask the dealer)



## MAX WEIGHT (kg)

width (m) rail		pic. pg. 6	Movelite 35			Movelite Wire-Free 35 RTS			Glydea Ultra 35e			Glydea Ultra 60e				Glydea Ultra 60e tandem		
			3	6	10	3	6	10	3	6	10	3	6	10	12	6	10	12
straight	one-sided	<b>A</b>	35	35	35	35	35	-	35	35	35	60	60	60	55	100	100	100
straight	curtain	<b>B</b>	35	35	35	35	35	-	35	35	35	60	60	60	55	100	100	100
90°	one-sided	<b>C</b>	35	25	20				35	25	20	45	45	45	35	100	80	80
90°	two-sided	<b>D</b>	35	25	20				35	25	20	45	45	45	35	100	80	80
90°	double one-sided	<b>E</b>	15	10	-				15	10	-	45	35	25	-	70	70	56
90°	double two-sided	<b>F</b>	15	10	-				15	10	-	35	35	25	-	70	70	56
45°	one-sided	<b>G</b>	35	15	-				35	15	-	45	35	25*	-	70	56*	-
45°	curtain	<b>H</b>	30	10	-				30	10	-	30	30	20*	-	70	56*	-

\*to 8m

## TYPES OF CREASING

### Creasing without tape

#### Distance of sliders 60 mm

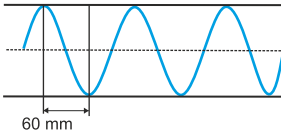

#### Distance of sliders 80 mm

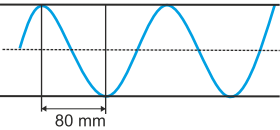

[EUR]

Creasing with tape (m)	60mm	80mm
Heavy Duty	18	10
Silent	40	26

### Creasing with tape

#### 80% Creasing

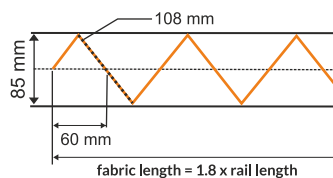

#### 100% Creasing

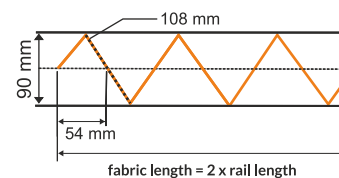

#### 120% Creasing

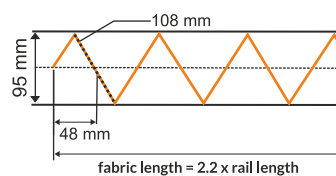

[EUR]

Creasing with tape (m)	80%	100%	120%
Heavy Duty	25	29	33
Silent	44	51	58

### 1. Standard curtain

The sliders in the rail are not connected to each other.

### 2. Creasing without tape

The sliders are connected to each other by a string allowing to adjust the degree of creasing of the curtain. Distance between the sliders: 60 or 80 mm.

### 3. Creasing with tape

The tape attached to the slider allows the degree of creasing of the curtain to be adjusted at three levels: 80%, 100% and 120%.

## RAIL TYPES - BENDING

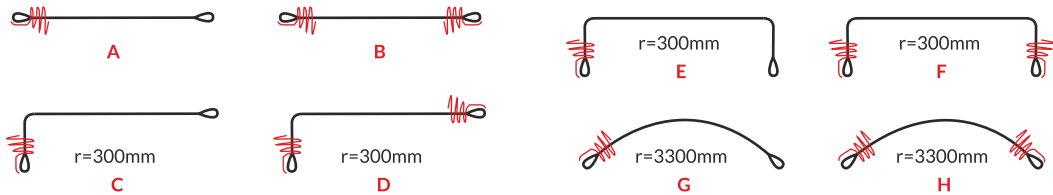

## MOTORS FOR MOVELITE RAIL [EUR]

	name	price
corded	Movelite 35 WT/DCT	127
	Movelite 35 RTS	155
re-chargeable	Movelite WireFree 35 RTS + power supply	278

## MOTOR SPECIFICATIONS

	Movelite 35	Glydea Ultra 35e/60e	Movelite Wirefree
power supply	90-240 V - 50-60 Hz	90-240 V - 50-60 Hz	24 Vdc / akumulator
max curtain weight	35 kg	35/60 kg	35 kg
max rail length	10 m	10-12 m	6 m
touch motion	yes (without WT)		yes
silent mode	no	yes	no
automatic end caps	yes		
adjustable end caps	yes (without WT)		yes
soft start/stop	no	yes (without WT)	no
speed [cm/s]	15	12,5/15/17,5/20	15
compatibility	WT/RTS		RTS

## MOTORS FOR GLYDEA ULTRA RAIL [EUR]

	name	price
wire	Glydea Ultra 35e WT/DCT	254
	Glydea Ultra 35e RTS	316
	Glydea Ultra 60e WT/DCT	302
	Glydea Ultra 60e RTS	349

## SDN MODULE [EUR]

drive control	price
Glydea Ultra DCT/RTS	56

## WALL MOUNTING [EUR/m]

bracket	price
curtain rod mounting to the wall	8
fixing of the curtain rod to the wall with double extension projection	11

## SWITCH WT [EUR]

switch	price
INIS WT with flush-mounted Mounting box (with support)	8
INIS WT with flush-mounted Mounting box (without support)	9
Inis 80 x 80 p/t (with support)	14
Inis 80 x 80 p/t (without support)	16
Smoove Uno WT (with support)	17
Smoove Uno WT (without support)	17
Smoove Duo WT (with support)	24
Smoove Duo WT (without support)	24

## WALL TRANSMITTER RTS [EUR]

transmitter	price
SMOOVE ORIGIN 1 RTS	38
SMOOVE ORIGIN 2 RTS	59
SMOOVE ORIGIN 4 RTS	73

## REMOTE CONTROL RTS [EUR]

remote control	price
SITUO 1 RTS	39
SITUO 5 RTS	63
TELIS 16 RTS	148





# MEASUREMENT

In order to measure you need to take into account the gap between the curtain rod and the wall or furniture. Leave a gap of 15 mm to the right and left of the curtain rod and 50 mm from the window. If two curtain rods are to be installed (e.g. one for a curtain) then they should be mounted with minimum distance of 100 mm from each other (pic.1).

The width of the motor is already included in the rail, so that the curtain covers the drive.

The width of the recess should be determined after taking into account:

- the technology of hemming the curtains,
- the thickness of the fabric,
- the type of creasing of the curtains,
- the use of overlapping hem,
- the presence of elements impeding the movement of the fabric (heaters, window ventilators, air conditioners, etc.).

PIC. 1

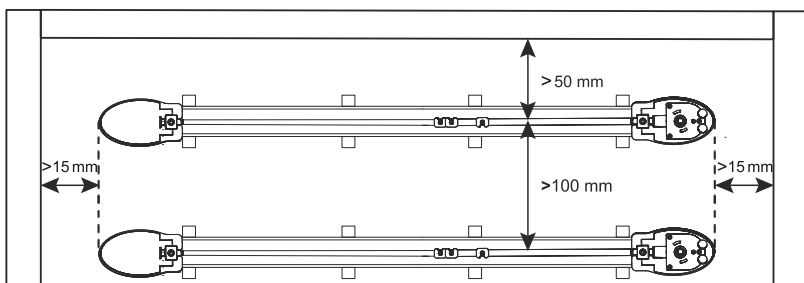

DIMENSIONS OF THE CURTAIN ROD IN CROSS-SECTION

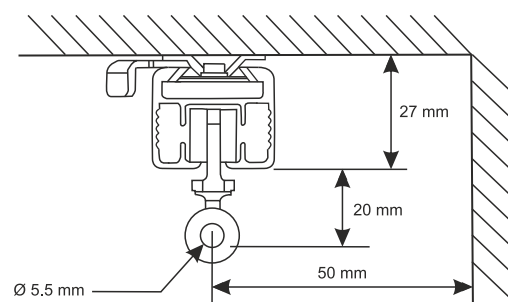

# ASSEMBLY

The motor must be connected according to the enclosed instructions.

1. Mark the position of the brackets - approximately every 50-60 cm,
2. Drill a hole and place the bracket,
3. Fix the bracket and place the hook to pull the curtain over the drive and pulley on the opposite side,
4. Fix the rail by turning the bracket,
- 5A. Unlock the drive, by moving the clip,
- 5B. Put the drive on the pulley,
- 5C. Lock the drive on the pulley by closing the clip.

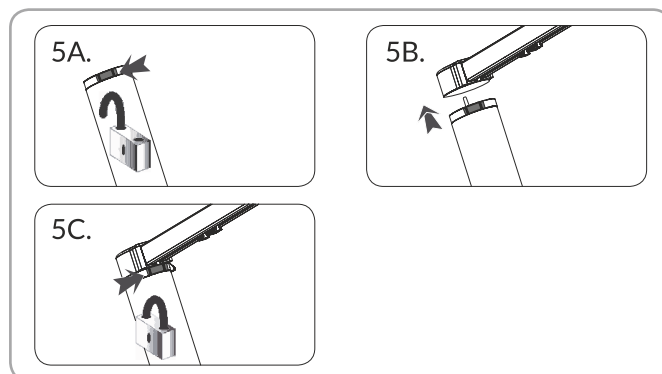
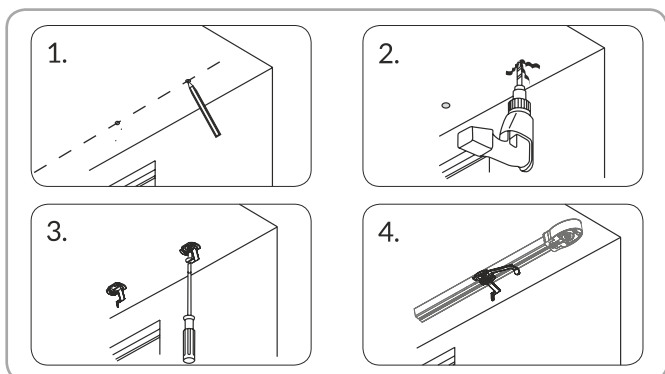



# FABRICS



## BLACKOUT FR

25 €/m<sup>2</sup>



FR 0335

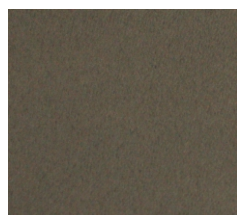

FR 0380

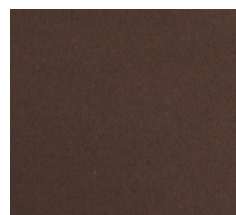

FR 9560

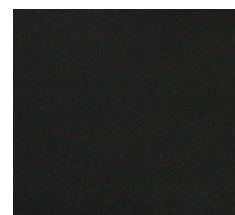

FR 9900

## JAZZ NOVA

33 €/m<sup>2</sup>

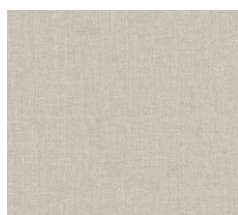

NOVA 06

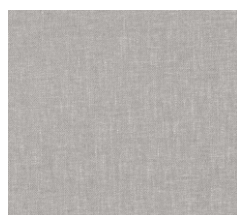

NOVA 10



NOVA 15



NOVA 20

## CROWN VELVET

38 €/m<sup>2</sup>

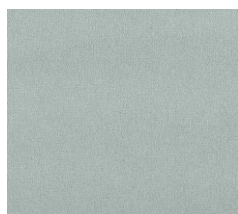

CROWN 05

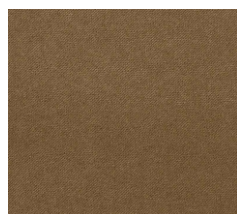

CROWN 13

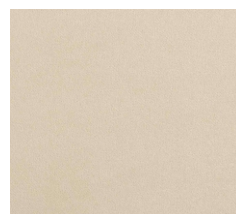

CROWN 26



CROWN 134



# CONTACT



### English

Michał Soszyński	<a href="mailto:msoszynski@mol.net.pl">msoszynski@mol.net.pl</a>	507 320 447
Marcelina Ryndak	<a href="mailto:mryndak@mol.net.pl">mryndak@mol.net.pl</a>	502 188 283
Oussema Mediouni	<a href="mailto:omediouni@mol.net.pl">omediouni@mol.net.pl</a>	502 188 546

### German

Joanna Marciniak	<a href="mailto:jmarciniak@mol.net.pl">jmarciniak@mol.net.pl</a>	502 188 547
------------------	--	-------------

### French

Oussema Mediouni	<a href="mailto:omediouni@mol.net.pl">omediouni@mol.net.pl</a>	502 188 546
------------------	--	-------------

